



**HERSCHEL HIFI  
FPSS IF1 UNIT**  
Yebes/FPSS/TR/2002-008

**YCF 6011 1101  
DM AMPLIFIER  
REPORT**



**Title:** YCF 6011 1101 DM Amplifier Report

---

**HIFI number** Yebes/FPSS/TR/2002-008

**Issue:** 1

**Date:** 28/05/2002

**Category:** 4

**Prepared by:** Isaac López Fernández

**Date:** 28/05/2002

**Checked by:**

**Date:** 28/05/2002

**Authorised by:**

**Date:**

**Distribution list:**

---

**SRON** Joost Adema  
Nick Whyborn

**Yebes** Carmen Diez

**Document Change Record:**

---

| <b>Date</b> | <b>Issue/Revision</b> | <b>Page</b> | <b>Change</b> |
|-------------|-----------------------|-------------|---------------|
|-------------|-----------------------|-------------|---------------|



## **INDEX OF DOCUMENTS**

- 1. YCF 6 4-8 GHz amplifier report (YCF 6011 1101)**
- 2. Power supply specifications**
- 3. ESD and power supply leakage protection of InP cryogenic HEMT amplifiers**

## YCF 6 4-8 GHz AMPLIFIER REPORT

### 1. Introduction

YCF series 6 are C band, 4-8 GHz low noise cryogenic amplifiers designed and built at the *Centro Astronómico de Yebes* for the development phase of the HERSCHEL project. They will be used in the Heterodyne Instrument Focal Plane Unit as first stage IF amplifiers. This document includes a description of the amplifiers and how to operate them, details about the tests performed, the measurements techniques utilized, plots and tables with the relevant data collected (an index is provided thereafter) and a summary page introducing the measurements.

The amplifier is intended to be used together with a **cryogenic isolator** connected to its input. PAMTECH has designed a 4-8 GHz unit for this purpose, model 55387 CTH1365K10, which can be mounted on top of the amplifier.

The unit should be biased by a **servo controlled power supply**, which sets the gate voltage for any given drain current, according to the specifications set in the attached document.

### 2. Description and operating conditions of the amplifier

- Figure 1 shows an outside view of the amplifier. There are two cavities machined in the chassis: the upper one includes the microstrip RF circuits and the bias board, while the lower one is provided in case additional EMC filtering is needed (and it allows easy access for the bias connector cables). RF input and output connectors are standard SMA. DC connector is a D-type 9 pin microminiature ITT-Cannon. The pinout is provided in figure 2. As seen in the figure, the RF input connector is the one located closer to the DC connector; the serial number of the unit is stamped on the long side of the amplifier, besides the DC connector.

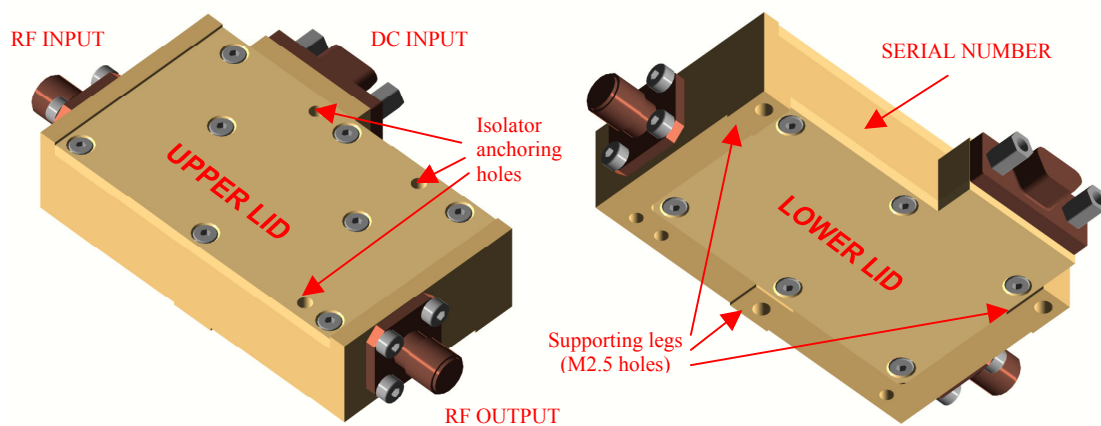
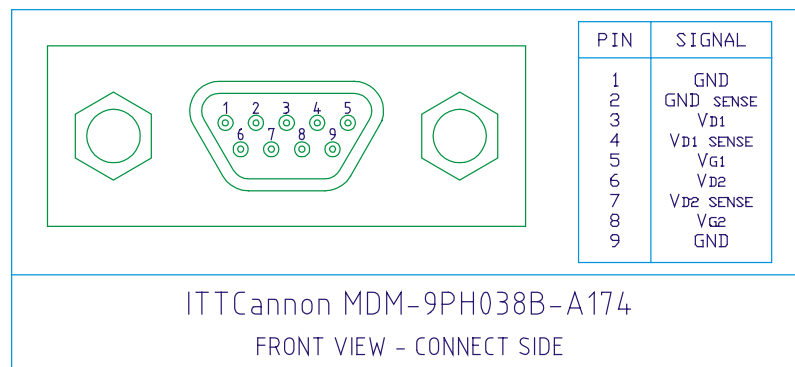
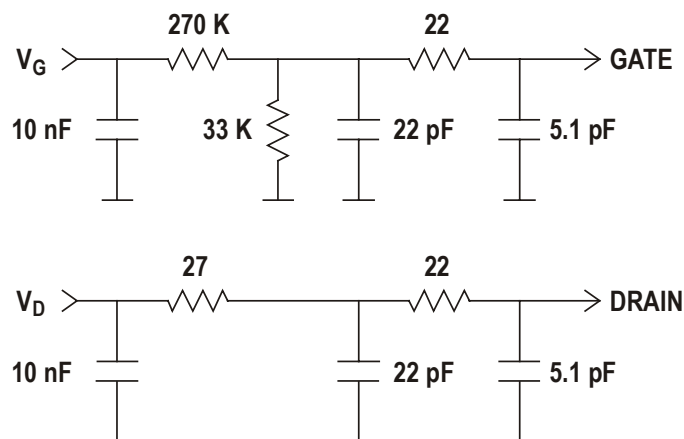

Figure 1: YCF 6 amplifier external elements

- The external dimensions and mechanical interfaces of the amplifier are shown in figures 4 and 5. Three M2.5 holes are provided to attach the amplifier to the cold plate, at the end of the three small supporting legs. Another three M2 holes exist on the top cover to fasten the isolator.
- YCF 6 are two stage amplifiers implementing TRW<sup>1</sup> InP transistors on both stages. The InP devices are very **ESD sensitive**; cautions must be taken in its manipulation. The bias circuits built in the amplifier include a 10 nF capacitor which acts as a charge divider to prevent damage to the transistors. A ~1:10 voltage divider is also implemented at the gates input lines to improve EMC and protect against ESD: high operating values of the gate voltages are normal. A schematic of these circuits is shown in figure 3. A separate document provides information on ESD prevention procedures, and safe unit handling and storage.
- One bias condition has been selected for the amplifier, which optimizes the device for noise, gain ripple and output reflection, keeping the power dissipation below **4 mW** (specification for HIFI dewar). Some improvement in noise and gain may be expected using a higher bias. Never exceed a drain voltage/current of 1.5 V / 10 mA for TRW InP transistors..

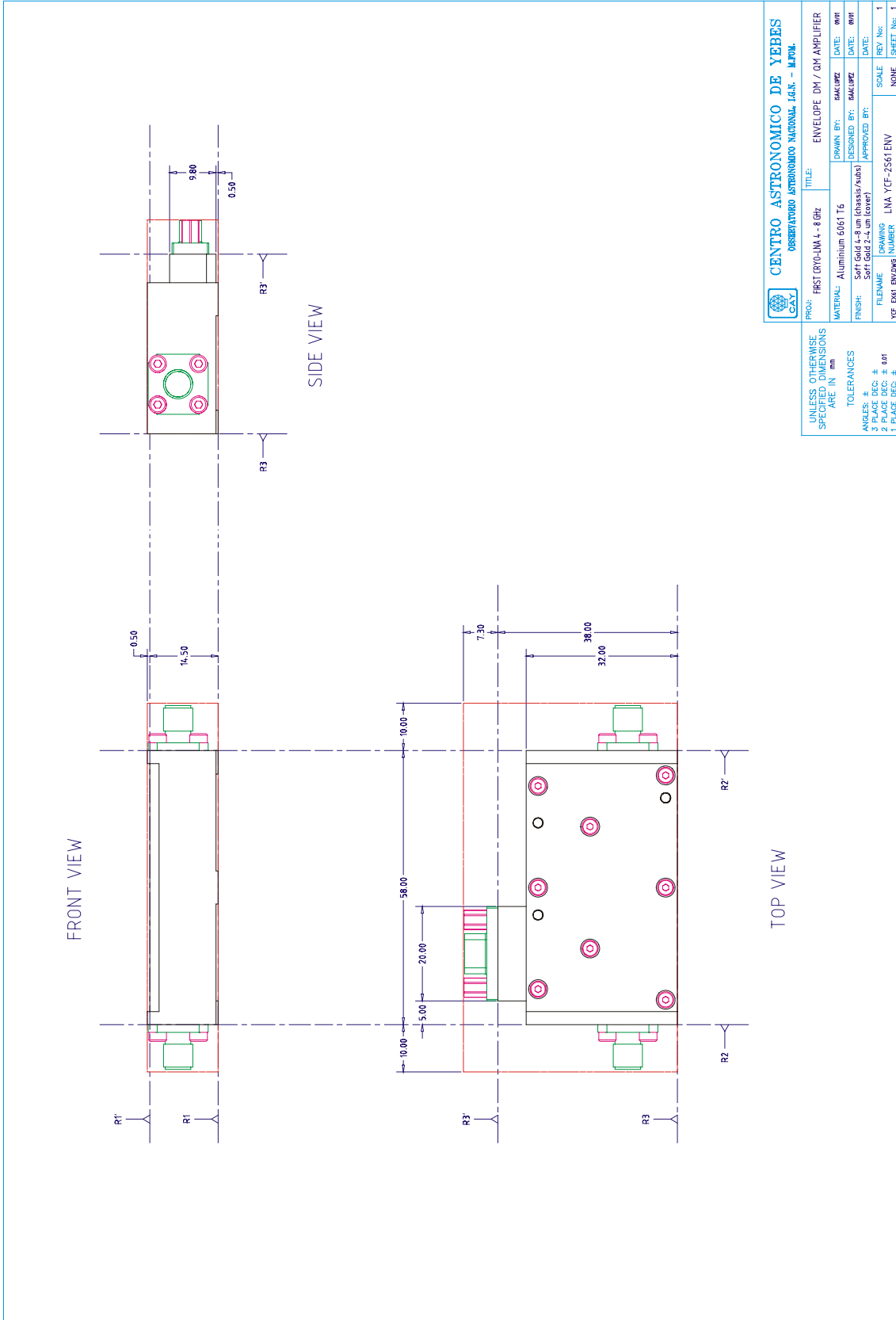

**Figure 2:** DC Connector pinout



**Figure 3:** YCF 6 bias circuits (inside the amplifier)

<sup>1</sup> Transistors provided by TRW under contract with JPL, as a contribution to HIFI.



| CENTRO ASTRONÓMICO DE YEBES |                                | OBSERVATORIO ASTRONÓMICO NACIONAL I.A.E. - I.A.O.N. |                            |
|-----------------------------|--------------------------------|---|----------------------------|
| PROJ:                       | FIRST (HYD-LIN 4 - 8 GHz)      | TITLE:  | ENVELOPE DM / GH AMPLIFIER |
| MATERIAL:                   | Aluminium 6061 T6              | DRAWN BY:   | RAM/OPZ                    |
| FINISH:                     | Soft Gold 2-8 um (chassis/sub) | DESIGNED BY:  | RAM/OPZ                    |
| FILENAME:                   | Soft Gold 2-4 um (cover)       | APPROVED BY:  | DATE:                      |
| NO_DRAWING:                 | LNA YCF-2561 ENV               | SCALE:  | REV No: 1                  |
|                             |                                |   | SHEET No: 1                |

UNLESS OTHERWISE SPECIFIED DIMENSIONS ARE IN mm

TOLERANCES

ANGLES: ±

3 PLACE DEC: ± 0.01

2 PLACE DEC: ±

1 PLACE DEC: ±

Figure 4: YCF 6 envelope

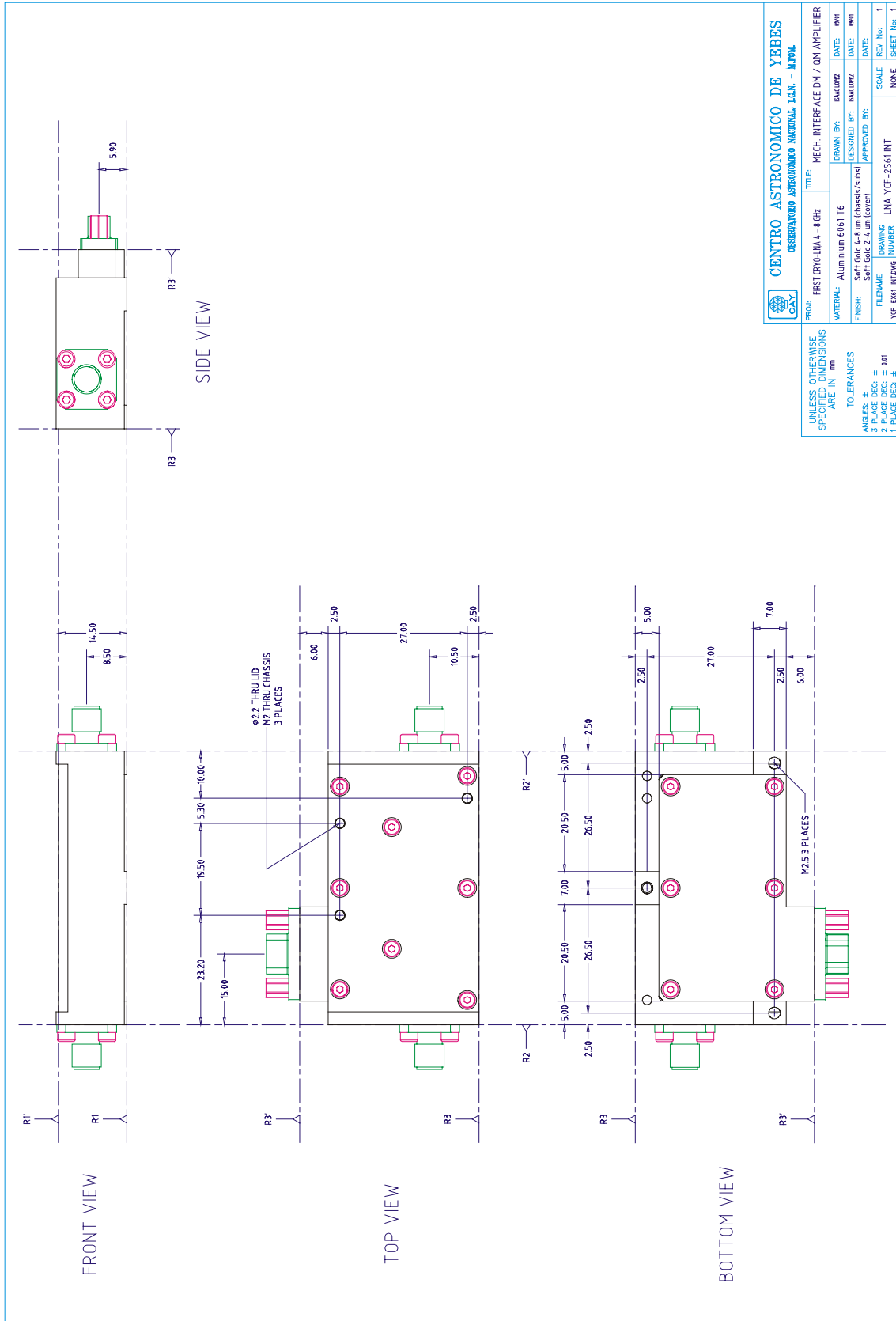

Figure 5: YCF 6 mechanical interfaces



## 3. Measurements

### 3.1 Description

**Noise temperature** (and gain) was measured with a system based in a computer controlled HP 8970 B Noise Figure Meter described in detail in [1]. Room temperature data was obtained with an HP 346 A noise diode. The DUT is cooled in a dewar with a CTI 350 refrigerator. Cryogenic measurements were taken with the "cold attenuator" method, using an HP 346 C noise diode (at room temperature) plus a 15 dB attenuator and a DC-Block cooled at cryogenic temperature (the DC-Block is included to avoid heating the active part of the attenuator by the inner conductor of the stainless steel coaxial line). Temperature is carefully monitored in the attenuator body using a Lake Shore sensor diode. The accuracy of the system for the amplifiers measured can be estimated with methods presented in [1], [2]. For present case, absolute accuracy (@  $3\sigma$ ) of measured noise temperature is estimated in  $\pm 9$  K at  $T_{amb}=297$  K and  $\pm 1$  K at  $T_{amb}=14$  K. Repeatability is better than this values by an order of magnitude.

**Reflection and gain** of the unit in the 350 dewar, at room and cryogenic temperatures, were measured using an HP 8757 A Scalar Network Analyzer in AC (modulated) mode. Note that the amplifier design is not optimized for input reflection, as it is intended to be used with an isolator at the input.

The same system, but in DC (non-modulated) mode was used to detect possible oscillations. The amplifier was tested at room and cryogenic temperature with one sliding short connected to the input and another to the output, and the wide band detector connected to the output. The test was repeated with an Agilent 9565 EC spectrum analyzer. No oscillation was detected.

**S parameters** of the amplifiers were measured with the HP 8510 C Vector Network Analyzer from 0.1 to 20 GHz to compare with less accurate SNA measurements, and to check for signs of possible out of band instability. This test was done at room temperature only, showing no sign of instability (Rollet constant greater than 1 at all frequencies), and good agreement with SNA data.

**Gain stability** (short term) was measured in a dewar with a CTI 1020 refrigerator, at a single frequency (6 GHz) using a continuously variable attenuator, air lines and the HP 8510 C Vector Network Analyzer, according to [3]. The results are presented in form of spectral density of normalized gain fluctuations. Several spectrums, in the range 0.012-2.34 Hz, are obtained by FFT of the VNA time domain data and averaged to reduce random fluctuations. The plots also show the value of the contribution of the system fluctuations, which is subtracted from the measurements. The reference value of the fluctuations at 1 Hz ( $\beta$ ) is also given, and its units are  $1/\sqrt{\text{Hz}}$  (when the exponent  $\alpha$  is 0.5). There is usually a peak at 1 Hz due to the cycle of the CTI 1020 refrigerator. In the same page phase fluctuation data are also provided in a similar fashion.





### 3.2 Index of plots

We provide plots of the scalar analyzer measurements, noise figure meter measurements and Mathcad files from vector analyzer measurements at ambient and cryogenic temperatures, for the optimum bias point.

1. Summary of performance, characteristics and bias
2. Cryogenic measurements
  - a. Noise temperature & gain
  - b. Input reflection loss & gain (up) and output reflection loss (down)
  - c. Gain stability
3. Room temperature measurements
  - a. Noise temperature & gain
  - b. Input reflection loss & gain (up) and output reflection loss (down)
  - c. Gain stability

### References

- [1] J. D. Gallego, “*Amplificadores Refrigerados de muy bajo ruido con transistores GaAs FET para la frecuencia intermedia de receptores de radioastronomía*,” Tesis Doctoral, Facultad de Ciencias Físicas, Universidad Complutense de Madrid, 1992.
- [2] J. D. Gallego, M. W. Pospieszalski, “*Accuracy of Noise Temperature Measurement of Cryogenic Amplifiers*,” Electronics Division Internal Report No. 285, National Radio Astronomy Observatory, Charlottesville, Virginia, March 1990.
- [3] J. D. Gallego, I. López Fernández, “*Measurements of Gain Fluctuations in GaAs and InP Cryogenic HEMT Amplifiers*,” Technical Report CAY 2000-1, February 2000.



# CENTRO ASTRONÓMICO DE YEBES

## OBSERVATORIO ASTRONÓMICO NACIONAL – IGN

Apartado 148  
19080 Guadalajara, SPAIN

Phone:  
Fax:

+34 949 29 03 11  
+34 949 29 00 63

### C-BAND CRYOGENIC AMPLIFIER REPORT

DATE: 20 may 2002

|                                   |                             |      |               |
|-----------------------------------|-----------------------------|------|---------------|
| BAND:                             | 4 - 8                       | S/N: | YCF 6011 1101 |
| TRANSISTOR 1 <sup>st</sup> STAGE: | TRW 200x0.1 um T-39 (IREL1) |      |               |
| TRANSISTOR 2 <sup>nd</sup> STAGE: | TRW 200x0.1 um T-39 (IREL1) |      |               |

| ROOM TEMPERATURE DATA (T=297 K) |            |                          |               |                  |
|---------------------------------|------------|--------------------------|---------------|------------------|
| OPTIMUM BIAS                    | $V_{d1} =$ | 1.25                     | $I_{d1} =$ 10 | $V_{g1} =$ 0.25  |
|                                 | $V_{d2} =$ | 1.25                     | $I_{d2} =$ 10 | $V_{g2} =$ -1.09 |
| AVERAGE NOISE TEMPERATURE:      | 55         | AVERAGE GAIN ± RIPPLE:   | 25.7±1.4      |                  |
| MINIMUM OUTPUT LOSS:            | 14.6       | GAIN FLUCTUATIONS @1 Hz: | 8.2E-6        |                  |

| CRYOGENIC TEMPERATURE DATA (T=15 K) |            |                          |              |                  |
|-------------------------------------|------------|--------------------------|--------------|------------------|
| OPTIMUM BIAS<br>(4 mW)              | $V_{d1} =$ | 0.90                     | $I_{d1} =$ 3 | $V_{g1} =$ 0.65  |
|                                     | $V_{d2} =$ | 0.45                     | $I_{d2} =$ 3 | $V_{g2} =$ -0.16 |
| AVERAGE NOISE TEMPERATURE:          | 4.0        | AVERAGE GAIN ± RIPPLE:   | 25.8±1.2     |                  |
| MINIMUM OUTPUT LOSS:                | 13.5       | GAIN FLUCTUATIONS @1 Hz: | 1.1E-4       |                  |

**REMARKS:**



NOISE AND GAIN MEASUREMENT PROGRAM WNOISE (350)

TIME 15:58:35 DATE : 9 Apr 2002 Tamb= 14.09

DATA STORED IN FILE: C:\HPBASIC\NOISE\DATA\M\_377.TXT

MODE: DSB (Freq>2.4 GHz)

YCF 6011 1101 6  
(.9 3.03 .65) (.45 3.01 -.16) (2.01 .07 13.8) (0 .01 13.7) 15

Tmin= 3.50 K @ F= 4.200 GHz. Tmean= 4.04  
GMIN= 24.62 dB GMAX= 27.05 dB  
Tcold= 14.09 K NdB Table= 5

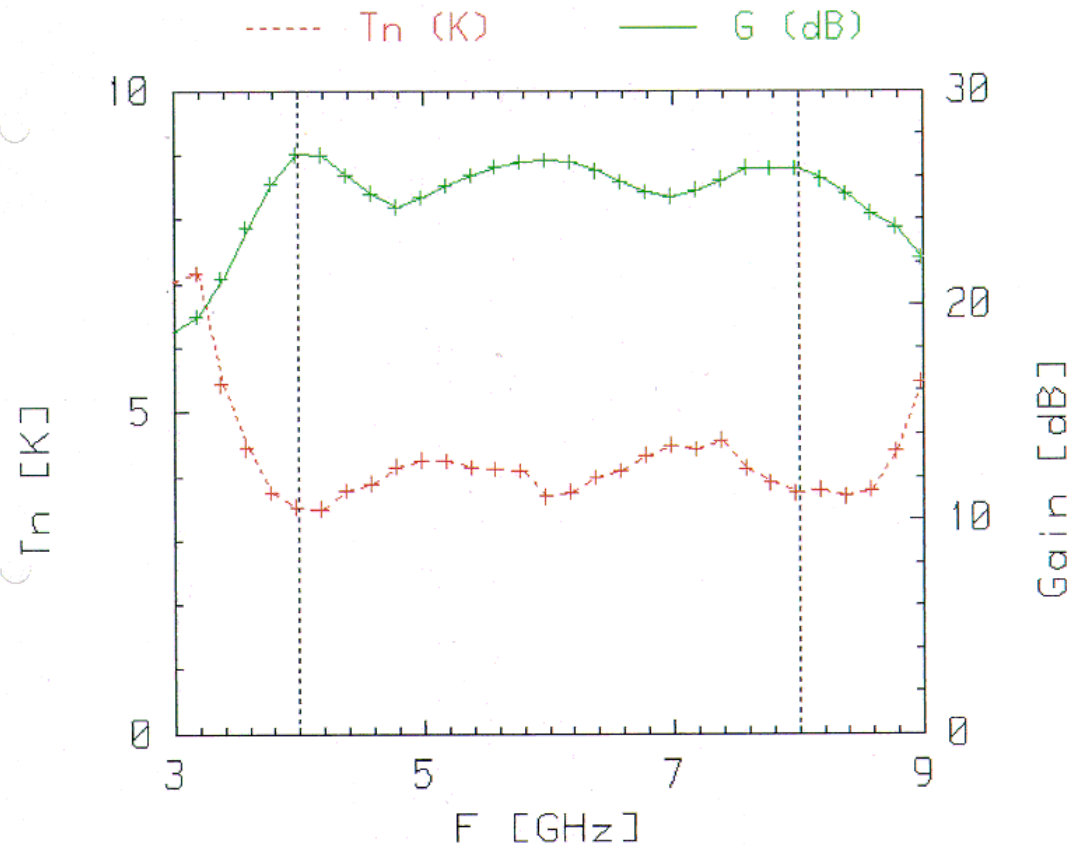



NOISE AND GAIN MEASUREMENT PROGRAM WNOISE (350)

TIME 15:58:35 DATE : 9 Apr 2002 Tamb= 14.09

DATA STORED IN FILE: C:\HPBASIC\NOISE\DATA\M\_377.TXT

MODE: DSB (Freq>2.4 GHz)

YCF 6011 1101 6  
(.9 3.03 .65) (.45 3.01 -.16) (2.01 .07 13.8) (0 .01 13.7) 15

Tmin= 3.50 K @ F= 4.200 GHz. Tmean= 4.04  
GMIN= 24.62 dB GMAX= 27.05 dB  
Tcold= 14.09 K NdB Table= 5

| F     | Gdut  | Tdut | IF  | RF  | NdB   | TH    | TC   |
|-------|-------|------|-----|-----|-------|-------|------|
| 3.000 | 18.79 | 7.05 | -25 | +10 | -2.28 | 194.4 | 22.9 |
| 3.200 | 19.47 | 7.18 | -25 | +10 | -2.28 | 194.6 | 22.8 |
| 3.400 | 21.29 | 5.44 | -30 | +10 | -2.27 | 194.7 | 22.8 |
| 3.600 | 23.62 | 4.45 | -30 | +10 | -2.27 | 194.8 | 22.8 |
| 3.800 | 25.67 | 3.75 | -35 | +10 | -2.26 | 195.0 | 22.8 |
| 4.000 | 27.05 | 3.53 | -35 | +10 | -2.26 | 195.1 | 22.8 |
| 4.200 | 27.04 | 3.50 | -35 | +10 | -2.25 | 195.6 | 22.7 |
| 4.400 | 26.06 | 3.78 | -35 | +10 | -2.24 | 196.0 | 22.7 |
| 4.600 | 25.24 | 3.89 | -35 | +10 | -2.22 | 196.5 | 22.7 |
| 4.800 | 24.62 | 4.15 | -35 | +10 | -2.21 | 196.9 | 22.7 |
| 5.000 | 25.04 | 4.26 | -35 | +10 | -2.20 | 197.4 | 22.7 |
| 5.200 | 25.59 | 4.25 | -35 | +10 | -2.18 | 198.2 | 22.7 |
| 5.400 | 26.06 | 4.14 | -35 | +10 | -2.16 | 199.0 | 22.6 |
| 5.600 | 26.45 | 4.12 | -35 | +10 | -2.14 | 199.8 | 22.6 |
| 5.800 | 26.70 | 4.09 | -25 | +0  | -2.12 | 200.6 | 22.6 |
| 6.000 | 26.78 | 3.69 | -25 | +0  | -2.10 | 201.4 | 22.6 |
| 6.200 | 26.69 | 3.76 | -25 | +0  | -2.07 | 202.4 | 22.5 |
| 6.400 | 26.27 | 3.99 | -25 | +0  | -2.05 | 203.5 | 22.5 |
| 6.600 | 25.76 | 4.09 | -25 | +0  | -2.02 | 204.6 | 22.5 |
| 6.800 | 25.29 | 4.34 | -25 | +0  | -2.00 | 205.6 | 22.5 |
| 7.000 | 25.09 | 4.49 | -25 | +0  | -1.97 | 206.7 | 22.5 |
| 7.200 | 25.39 | 4.43 | -25 | +0  | -1.94 | 208.0 | 22.4 |
| 7.400 | 25.86 | 4.57 | -25 | +0  | -1.91 | 209.2 | 22.4 |
| 7.600 | 26.42 | 4.13 | -25 | +0  | -1.88 | 210.5 | 22.4 |
| 7.800 | 26.40 | 3.90 | -25 | +0  | -1.85 | 211.8 | 22.4 |
| 8.000 | 26.39 | 3.74 | -25 | +0  | -1.82 | 213.1 | 22.4 |
| 8.200 | 25.88 | 3.79 | -25 | +0  | -1.79 | 214.5 | 22.4 |
| 8.400 | 25.20 | 3.69 | -25 | +0  | -1.76 | 215.9 | 22.3 |
| 8.600 | 24.29 | 3.79 | -25 | +0  | -1.72 | 217.3 | 22.3 |
| 8.800 | 23.66 | 4.40 | -25 | +0  | -1.69 | 218.7 | 22.3 |
| 9.000 | 22.22 | 5.48 | -25 | +0  | -1.66 | 220.1 | 22.3 |

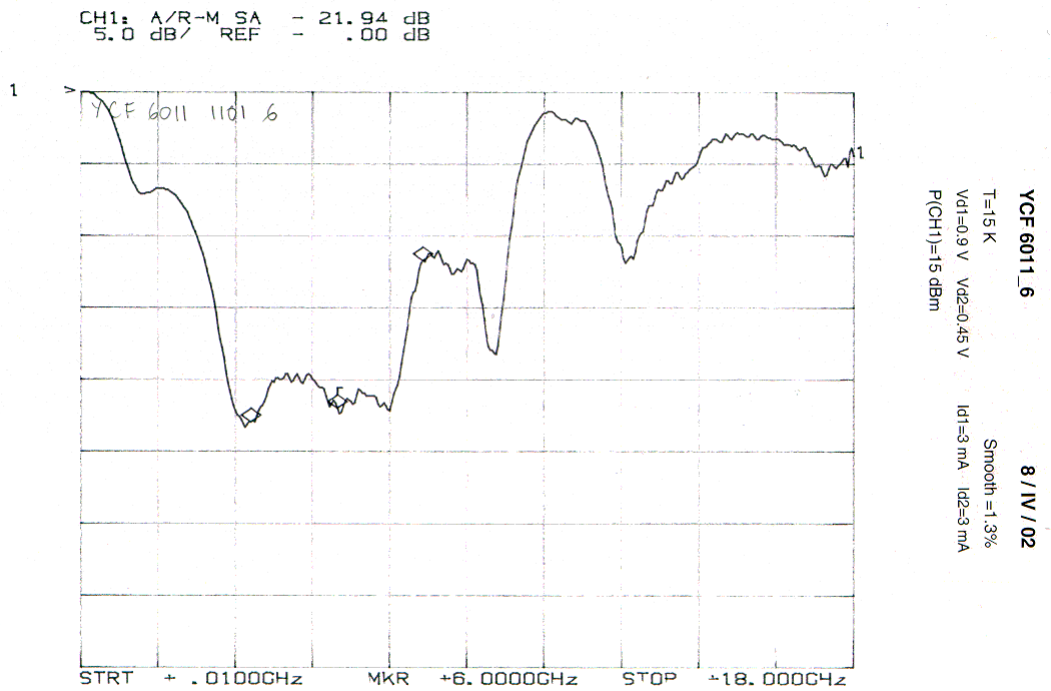
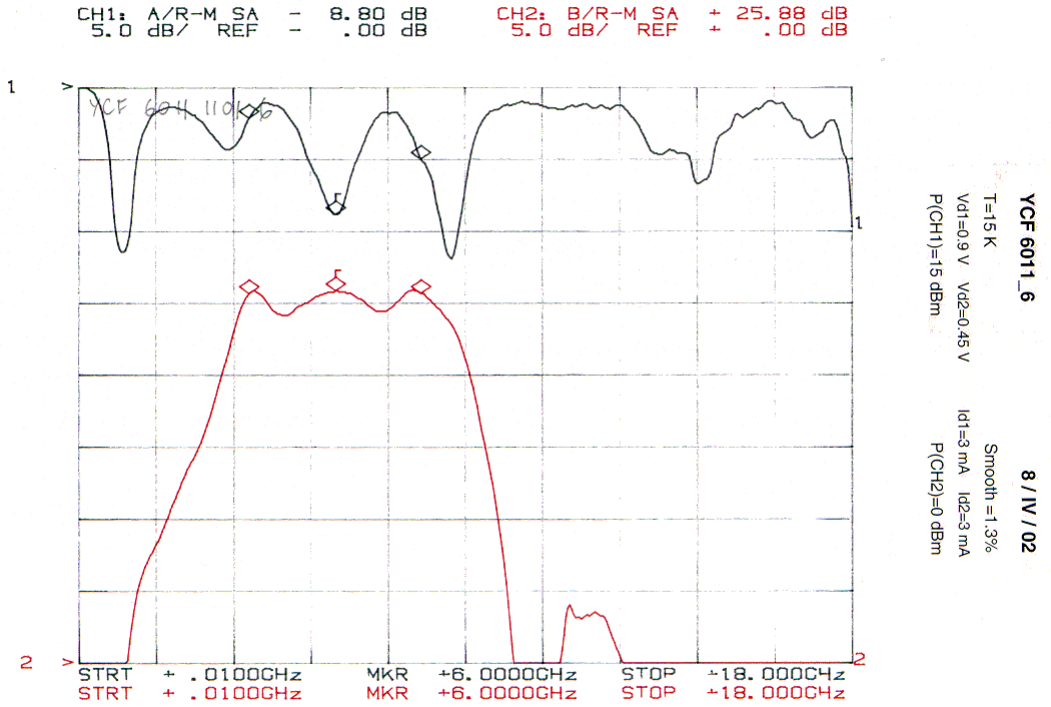



## GAIN STABILITY TEST

cal\_file:= "cal\_data\cal.prn"

N\_scans := 50

data\_directory:= "YCF\_6011\_CRY"

file\_prefix= "F"

file\_suffix= ".prn"

out\_file:= "results.prn"

Frequency range for the fit:

f\_fit\_min := 0.1

f\_fit\_max := 0.9

YCF 6011 VD=(0.90,0.45) ID=(3,3) T=15.15 K



$\alpha = 0.321$

$\beta = 1.138 \times 10^{-4}$

fit =  $\beta \cdot f^{-\alpha}$

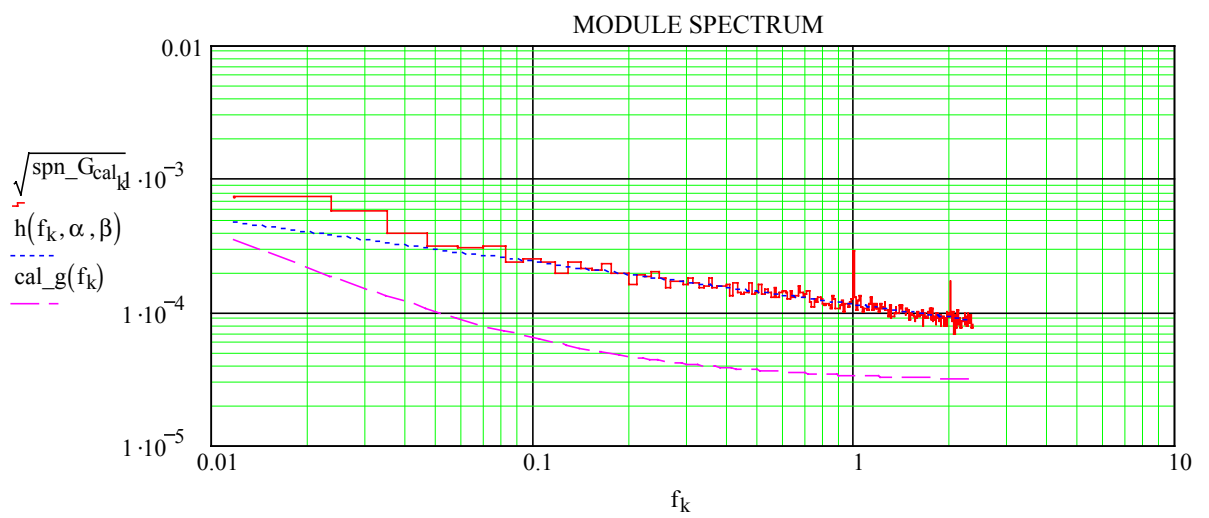

$\alpha = 0.339$

$\beta = 2.128 \times 10^{-3}$

fit =  $\beta \cdot f^{-\alpha}$

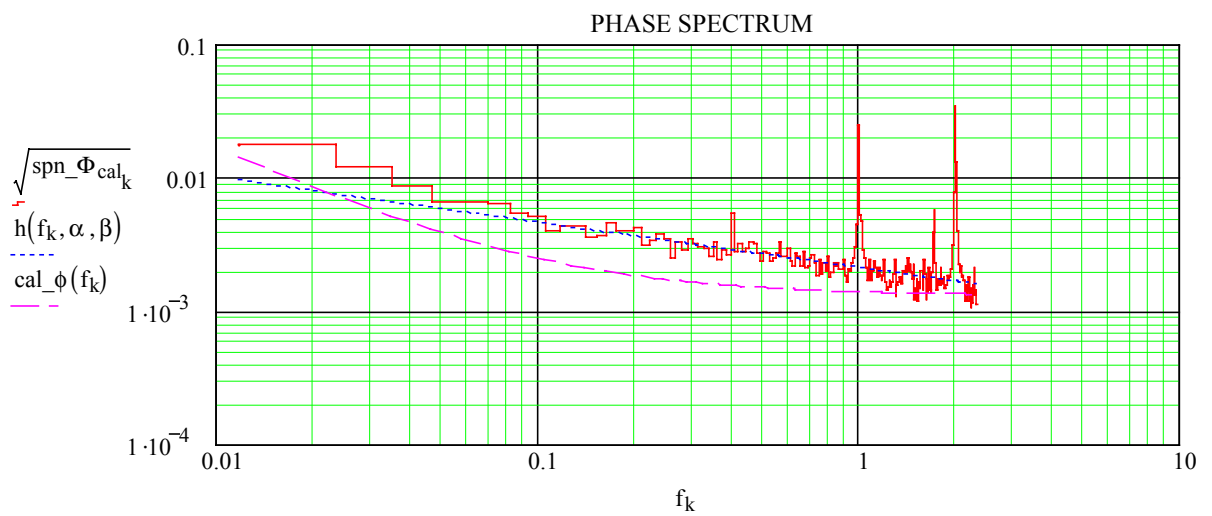



NOISE AND GAIN MEASUREMENT PROGRAM WNOISE (350)

TIME 13:41:58 DATE : 10 Apr 2002 Tamb= 293

DATA STORED IN FILE: C:\HPBASIC\NOISE\DATA\M\_380.TXT

MODE: DSB (Freq>2.4 GHz)

YCF 6011 1101 6  
(1.25 10 .25) (1.25 10 -1.09) (2.01 .07 13.8) (0 0 3.42) 15

Tmin= 50.19 K @ F= 4.600 GHz. Tmean= 55.31  
GMIN= 24.31 dB GMAX= 27.12 dB  
Tcold= 300.50 K NdB Table= 1

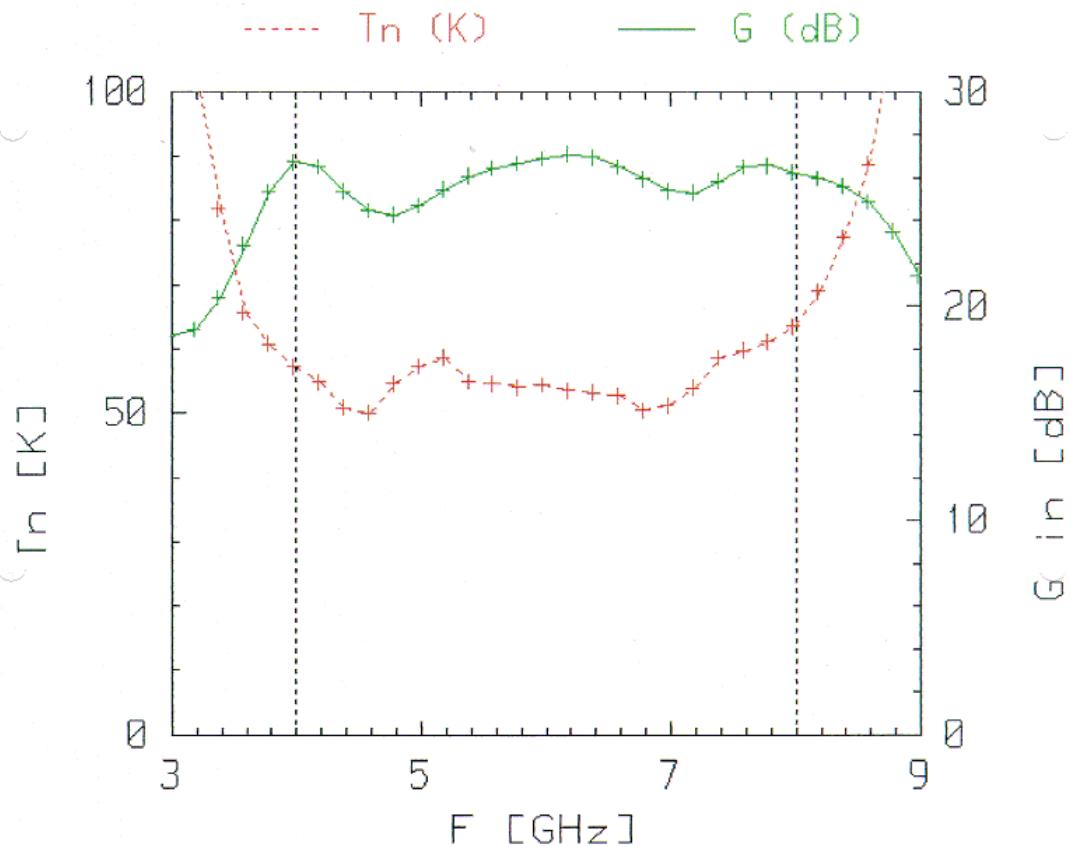



NOISE AND GAIN MEASUREMENT PROGRAM WNOISE (350)

TIME 13:41:58 DATE : 10 Apr 2002 Tamb= 293

DATA STORED IN FILE: C:\HPBASIC\NOISE\DATA\M\_380.TXT

MODE: DSB (Freq>2.4 GHz)

YCF 6011 1101 6  
(1.25 10 .25) (1.25 10 -1.09) (2.01 .07 13.8) (0 0 3.42) 15

Tmin= 50.19 K @ F= 4.600 GHz. Tmean= 55.31  
GMIN= 24.31 dB GMAX= 27.12 dB  
Tcold= 300.50 K NdB Table= 1

| F     | Gdut  | Tdut   | IF  | RF  | NdB   | TH     | TC    |
|-------|-------|--------|-----|-----|-------|--------|-------|
| 3.000 | 18.59 | 119.85 | -25 | +0  | +4.93 | 1192.4 | 300.5 |
| 3.200 | 18.94 | 105.75 | -25 | +0  | +4.92 | 1191.2 | 300.5 |
| 3.400 | 20.44 | 81.84  | -25 | +0  | +4.92 | 1189.9 | 300.5 |
| 3.600 | 22.88 | 65.76  | -30 | +0  | +4.91 | 1188.7 | 300.5 |
| 3.800 | 25.33 | 60.89  | -30 | +0  | +4.91 | 1187.4 | 300.5 |
| 4.000 | 26.76 | 57.30  | -35 | +0  | +4.90 | 1186.2 | 300.5 |
| 4.200 | 26.55 | 54.95  | -35 | +0  | +4.90 | 1186.2 | 300.5 |
| 4.400 | 25.40 | 50.90  | -35 | +0  | +4.90 | 1186.2 | 300.5 |
| 4.600 | 24.52 | 50.19  | -30 | +0  | +4.90 | 1186.2 | 300.5 |
| 4.800 | 24.31 | 54.69  | -30 | +0  | +4.90 | 1186.2 | 300.5 |
| 5.000 | 24.75 | 57.36  | -30 | +0  | +4.90 | 1186.2 | 300.5 |
| 5.200 | 25.48 | 58.78  | -30 | +0  | +4.91 | 1188.7 | 300.5 |
| 5.400 | 26.09 | 55.06  | -30 | +0  | +4.92 | 1191.2 | 300.5 |
| 5.600 | 26.46 | 54.71  | -35 | +0  | +4.94 | 1193.6 | 300.5 |
| 5.800 | 26.70 | 54.14  | -35 | +0  | +4.95 | 1196.1 | 300.5 |
| 6.000 | 26.94 | 54.54  | -35 | +0  | +4.96 | 1198.7 | 300.5 |
| 6.200 | 27.12 | 53.66  | -35 | +0  | +4.97 | 1199.9 | 300.5 |
| 6.400 | 26.98 | 53.26  | -35 | +0  | +4.97 | 1201.2 | 300.5 |
| 6.600 | 26.54 | 52.81  | -35 | +0  | +4.98 | 1202.4 | 300.5 |
| 6.800 | 25.97 | 50.49  | -35 | +0  | +4.98 | 1203.7 | 300.5 |
| 7.000 | 25.41 | 51.28  | -35 | +0  | +4.99 | 1205.0 | 300.5 |
| 7.200 | 25.31 | 54.11  | -35 | +0  | +5.02 | 1210.9 | 300.5 |
| 7.400 | 25.86 | 58.65  | -35 | +0  | +5.05 | 1216.8 | 300.5 |
| 7.600 | 26.56 | 59.82  | -25 | -10 | +5.07 | 1222.8 | 300.5 |
| 7.800 | 26.59 | 61.18  | -25 | -10 | +5.10 | 1228.9 | 300.5 |
| 8.000 | 26.25 | 63.58  | -25 | -10 | +5.13 | 1234.9 | 300.5 |
| 8.200 | 25.99 | 69.02  | -25 | -10 | +5.15 | 1239.3 | 300.5 |
| 8.400 | 25.63 | 77.55  | -25 | -10 | +5.17 | 1243.7 | 300.5 |
| 8.600 | 24.90 | 88.86  | -25 | -10 | +5.19 | 1248.1 | 300.5 |
| 8.800 | 23.52 | 109.68 | -30 | +0  | +5.21 | 1252.5 | 300.5 |
| 9.000 | 21.48 | 138.78 | -30 | +0  | +5.23 | 1256.9 | 300.5 |



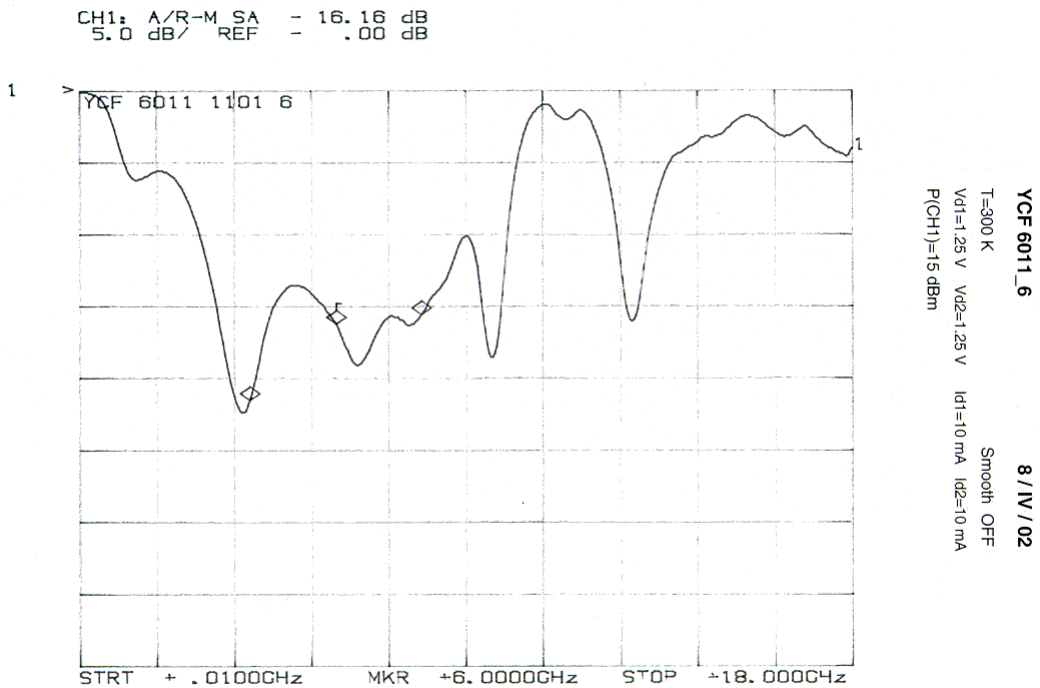
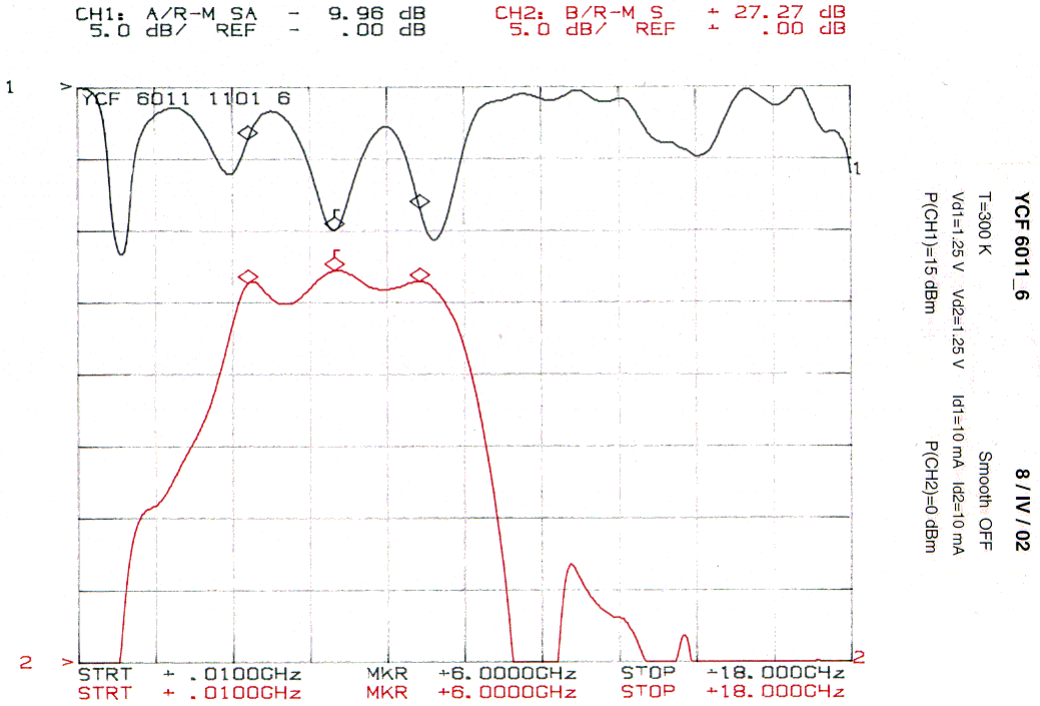



## GAIN STABILITY TEST

cal\_file:= "cal\_data\cal.prn"

N\_scans := 50

data\_directory:= "YCF\_6011\_AMB"

file\_prefix= "F"

file\_suffix= ".prn"

out\_file:= "results.prn"

Frequency range for the fit:

f\_fit\_min := 0.1

f\_fit\_max := 0.9

YCF 6011 VD=(1.25,1.25) ID=(10,10) T=289 K



$\alpha = 1.111$

$\beta = 8.176 \times 10^{-6}$

fit =  $\beta \cdot f^{-\alpha}$

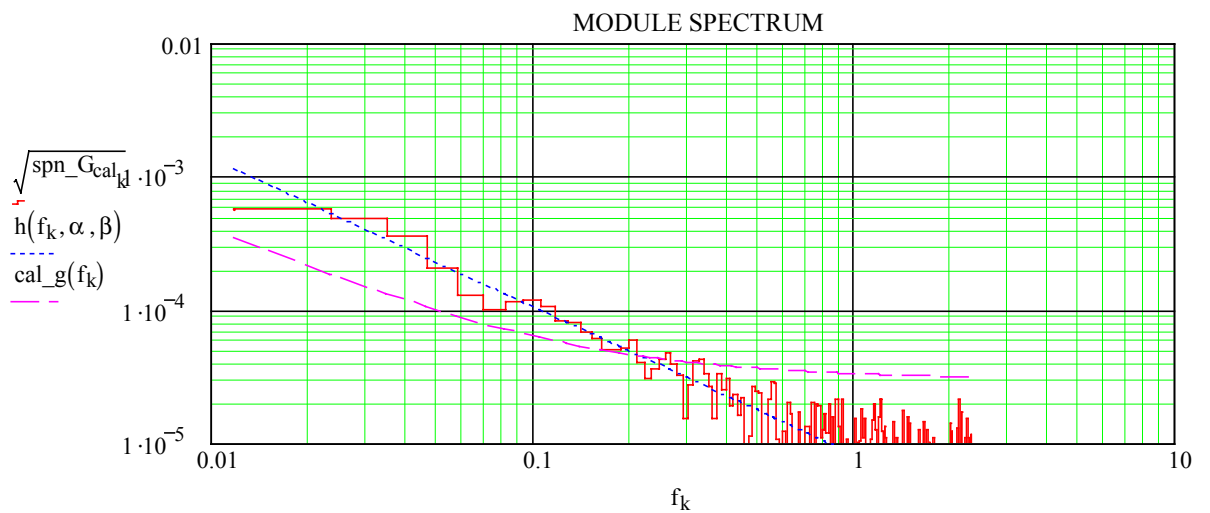

$\alpha = 1.706$

$\beta = 6.834 \times 10^{-5}$

fit =  $\beta \cdot f^{-\alpha}$

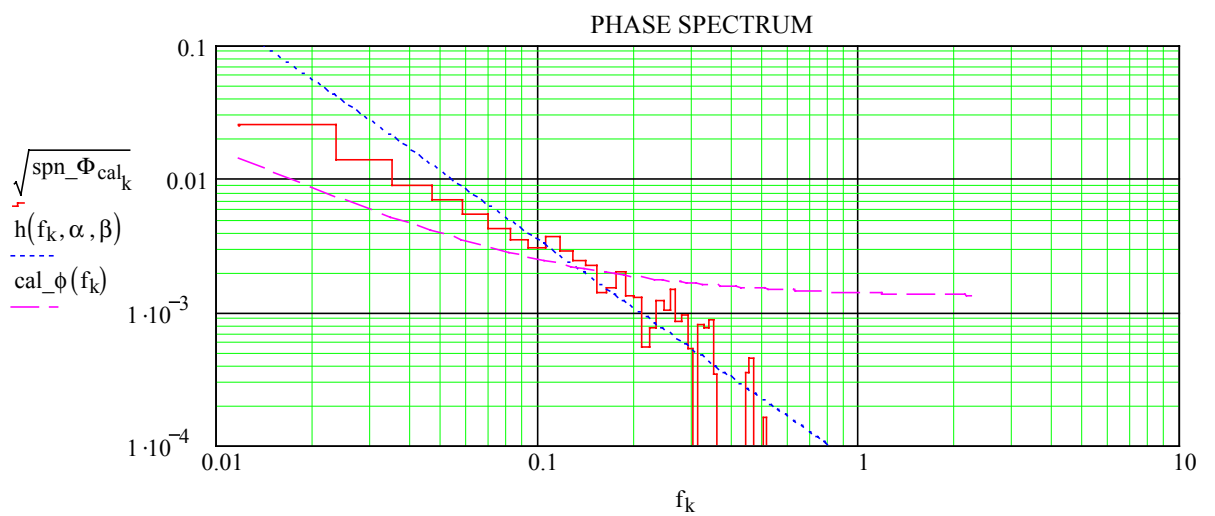



## POWER SUPPLY SPECIFICATIONS

Specifications for the power supply of FIRST to reach the electrical specifications described in paragraph 3 of the First Stage IF Cryogenic Amplifier Specifications (YEBES/FPU/SP/2000-001).

| Amplifier drain voltage supply characteristics |                     |  |
|--|---------------------|--|
| Parameter                                      | Value               | Remarks  |
| Drain voltage range                            | 0 ... +1.5V (=FSR)  | Commandable, constant voltage supply, drain voltage sense w.r.t. source voltage sense. |
| Absolute accuracy                              | $\pm 0.02V$         |  |
| Step size (setting)                            | $\leq 0.01V$        |  |
| Drain Voltage Noise                            | $< 800nV Hz^{-0.5}$ | @ 1 Hz   |
| Total Drain Voltage Noise                      | $< 20\mu V_{rms}$   | 0.1-800 Hz   |

| Amplifier drain current supply characteristics                       |                   |  |
|--|-------------------|--|
| Parameter  | Value             | Remarks  |
| Output current range   | 0 ... 10mA        | Commandable current feedback power supply controlling gate voltage |
| Absolute accuracy  | $\pm 0.10mA$      |  |
| Step size (setting)  | $\leq 0.02mA$     |  |
| Regulation bandwidth   | From DC to 20Hz   | 3 dB frequency for suppressing                                     |
| Suppression of Drain Current Fluctuations *                          | $> 25 dB$         | @ 1 Hz   |
| Residual Drain Current Fluctuations (caused only by power supply) ** | $< 8nA Hz^{-0.5}$ | @ 1 Hz   |

\* This suppression is to reduce the effect of the intrinsic fluctuations of the transconductance of the transistor.

\*\* This is the noise introduced by the power supply not taking into account the effects of the intrinsic fluctuations of the transconductance of the transistor.

### Applicable conditions

Transconductance Range: 5-20mS (including divider by 10 in gate and bias circuit but not EMC protection).

### Absolute maximum ratings

Output drain voltage/current limit (Zener Diode): -0.5 ... +7V /  $\pm 35mA$  (voltage limited by Zener diode and current by output resistor).

Output gate voltage/current limit (Zener Diodes):  $\pm 7V$  /  $\pm 7mA$  (voltage limited by two Zener diodes connected in anti-series and current by output resistor).



## ESD AND POWER SUPPLY LEAKAGE PROTECTION OF InP CRYOGENIC HEMT AMPLIFIERS

### Introduction

Cryogenic amplifiers made with InP HEMTs have been found very sensitive to ESD (electrostatic discharges) and leakage from the power supplies. The handling of these devices requires especial precautions beyond the normal care taken with cryogenic amplifiers made with commercial GaAs HEMTs. Especial procedures should be followed during assembly of the amplifiers as well as during tests and operation to avoid permanent damage to the devices. The most common mode of failure is the total or partial destruction of the gate of the transistors. Partially damaged devices may lose one or more gate fingers and show poor or no pinch off, even if the gate junction still shows diode characteristics. Totally damaged devices may appear as a short circuit (or low resistance) from drain to source. Sometimes, but not often, the device may appear as an open circuit.

ESD is not the only problem. Leakage of soldering irons, bonding machines and even power supplies of the amplifiers has produced many failures. All the equipment used in the assembly test and operation of the amplifiers should be checked for leakage. Most of the field problems detected have been caused by 50 Hz current leakage of input transformers of floating DC power supplies. This leakage is due to the capacitive coupling between primary and secondary of the transformers and it is always present unless there is a grounded faraday shield between the two windings or other especial precautions are taken

### Procedure for assembly of the amplifiers

1. Technicians manipulating amplifiers should wear grounded wrist straps.
2. The bench for the assembly of the amplifiers should have a dissipative mat connected to ground.
3. A short circuit should be put in the power connector of the amplifier at all times during assembly (the short circuit should short all pins together to the case). The short circuit will only be removed for testing the amplifier or when connected for operation.
4. Coaxial SMA short circuits should be connected to input and output RF connectors at all times during assembly. The short circuits will only be removed for testing the amplifier or when connected for operation.
5. The soldering irons used for assembly should be adequately grounded. It should be checked that no voltage respect to ground is measured on the tip with the soldering iron on and off. The maximum voltage allowed will be 0.020 Vrms respect to ground measured with a high input impedance ( $> 10 \text{ M}\Omega$ ) voltmeter in AC mode.
6. The tip of the bonding and welding machines used for assembly of the amplifier should be adequately grounded. It should be checked that no voltage respect to ground is measured with machines on or off. The maximum voltage allowed will be 0.020 Vrms respect to ground measured with a high input impedance ( $> 10 \text{ M}\Omega$ ) voltmeter in AC mode.
7. Be very careful with any measurement instrument used during assembly. If ohmmeters are used for verification of internal cabling, battery operated units are preferred. Make all necessary verifications before the assembly of the transistors when possible. The assembly of the transistors should be the last operation to avoid unnecessary risks.



## Procedure for test and operation of the amplifiers

1. The amplifier should be kept with a short circuit in the power connector when not in use. The short circuit should short all pins together and to the case. The short circuit should only be removed if adequate ESD and leakage protection precautions have been taken.
2. Most failures in cryogenic amplifiers are produced when connecting or disconnecting the amplifier to/from the power supply. **A very careful procedure should be followed.**
3. Make sure that the power supply is **off** before connecting or disconnecting the power supply cable to/from the amplifier.
4. Make sure that the power supply and the amplifier are connected to the same protective ground before connecting or disconnecting the power supply cable to/from the amplifier.
5. Very especial care should be taken in case of a DC power supply floating respect to the protective ground. This produces most failures. It is safer to connect the **return** terminal at the output of the DC power supply to the protective **ground** permanently on the power supply side. If this is not possible (for example to avoid ground loops with long cables), a provisional connection from the return of the power supply to the amplifier case should be **made prior to any connection or disconnection** of the power supply cable. Always make sure that there is no voltage between the return of the power supply and the protective ground (case of the amplifier) before connecting the power supply cable. The maximum allowed voltage will be 0.020 Vrms measured with a high input impedance ( $> 10 \text{ M}\Omega$ ) voltmeter in AC mode.
6. The power supply should have adequate built in protection to avoid excessive voltage and currents in the transistors in case of power supply failure and during the transients produced when the power supply is switched on or off. Adequate Zenner diodes can be used in parallel with the outputs, and adequate series resistors in series. If the protections are designed adequately, the amplifier will survive even in case of errors in the connections of the cables.

## Storage of the amplifiers

1. The amplifiers should be stored in a clean dry anti-static environment.
2. The amplifier should be stored with short circuits in the power and RF connectors.
3. For permanent storage desiccators with less than 20% relative humidity should be used. The preferred method of storage is in dry nitrogen containers.
4. For transportation, and for short-term storage, anti-static plastic bags with silica gel bags to keep low relative humidity should be used.